

KAMD42P-A

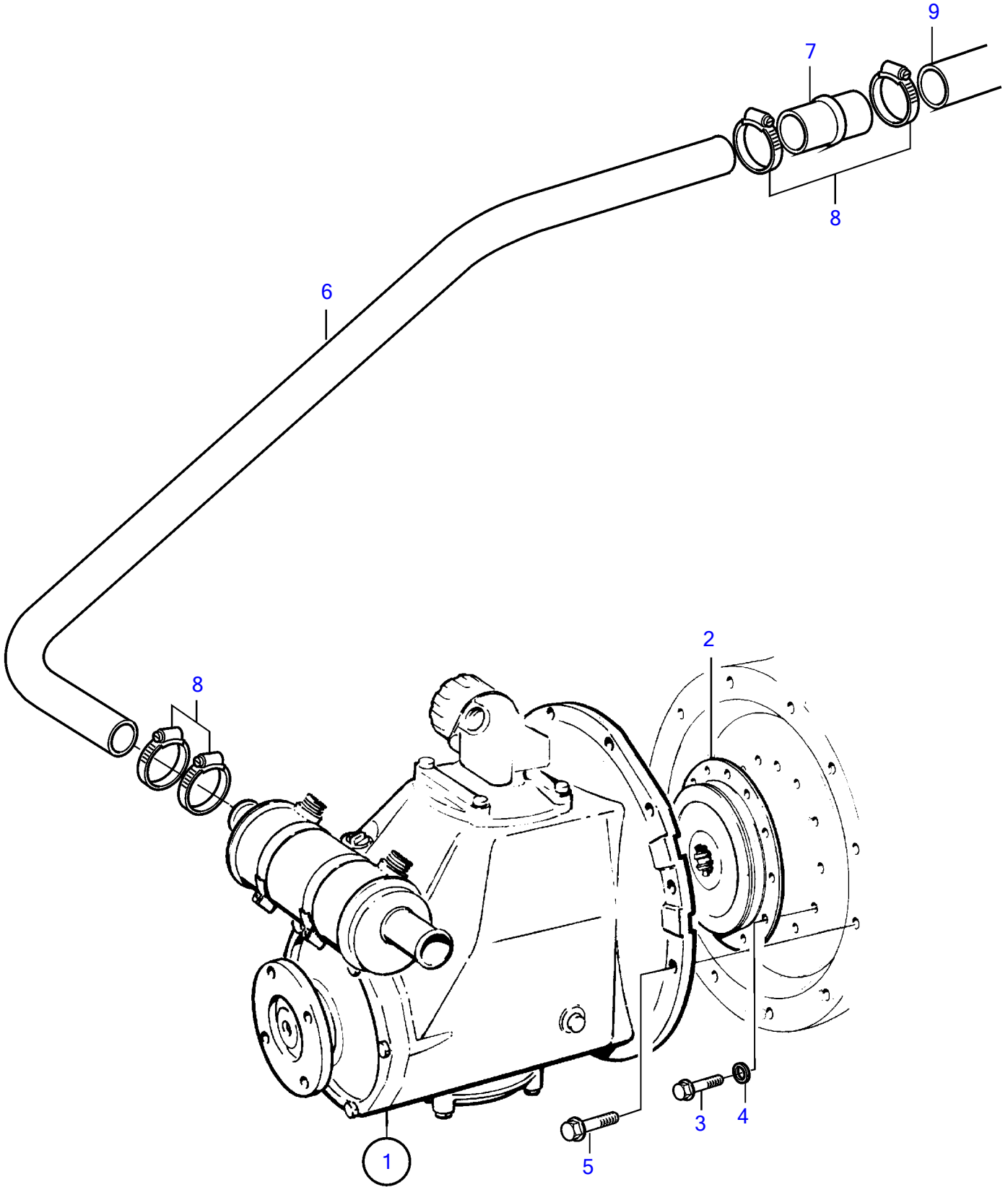

KAMD42P-A

REF	PART NO.	QTY	DESCRIPTION	SEE SEC.	NOTES
1		1	Reversing gear		
			.	605	
2	854753	1	Vibration damper		Replaced by 1pcs 3582751, vibration damper, 6pcs 959227, screw and 6pcs 941907, spring washer.
	3582751	1	Oscillation damper		
3	959227	6	Hex. socket screw		
4	941907	6	Spring washer		
5	946752	9	Flange screw		
6	861739	1	Hose		
7	861090	1	Tube		
8	961669	4	Hose clamp		
9	861738	1	Hose		Reverse gear-sea water pump.